

+ G3K

3-WAY HIGH PRESSURE BALL VALVES

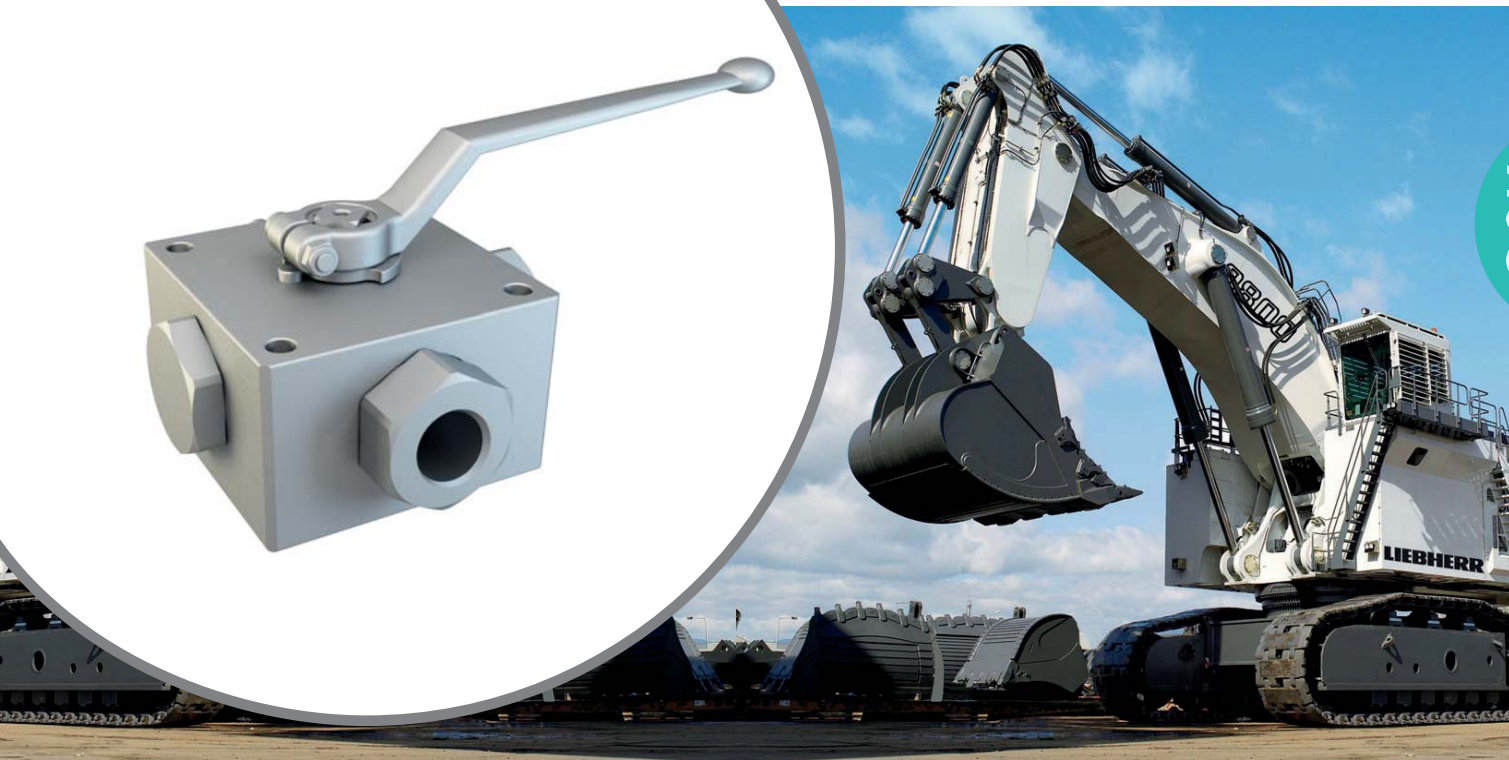
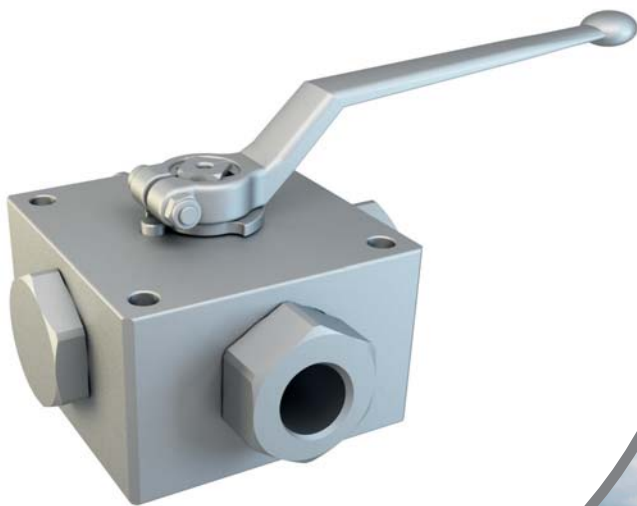

G3K

CARBON STEEL

- Type: ball valve G3K 3 way
- Body: square
- Material: 1,0737/1,0737
- Ball seats: from DN6 up to DN25
- O-Rings: NBR
- Operating pressure: 500 Bar depending on valve size and seal materials selected
- Temp range: -20°C to +100°C depending on seal material selected

G3K	K01	G 1/4		DN6	1	1	1	1	A	B
Type and way of valve	Type of way	GAS DIN/ISO 228 BSP	NPT ANSI/ASME B1.20.1	Nominal dimension	Body material	Adapter material	Stem material	Ball material	Ball seat material	Adapter and stem seal material
G3K 3-way	L K01	G 1/4	N 1/4	DN6	1 1,0737	1 1,0737	1 1,0737	1 1,0737	A POM	B NBR
	T K02	G 3/8	N 3/8	DN10						
	X K14	G 1/2	N 1/2	DN13						
		G 3/4	N 3/4	DN20						
		G 1	N 1	DN25						
		G 1 1/4 R	N 1 1/4 R							
	G 1 1/2 R	N 1 1/2 R								





3-WAY HIGH PRESSURE BALL VALVES

Specialist in Ball Valves

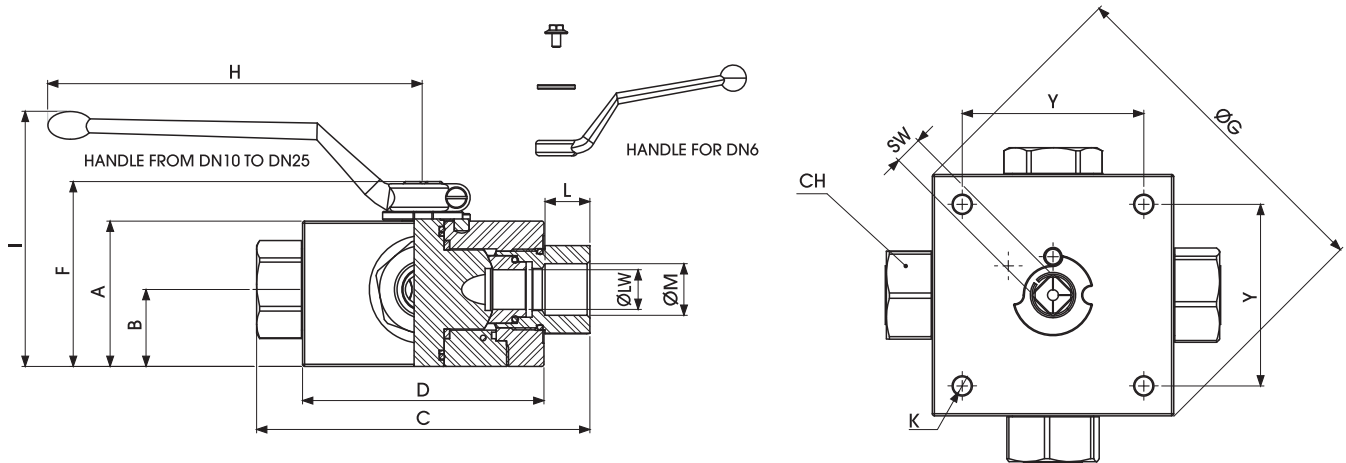

G3K DIN ISO 228 BSP

Standard

TYPE	PN	DN	A	B	C	D	E	F	ØG	H	I	L	ØM	CH	K	Y	SW	KG
G3K G 1/4	50 MPa	6	42	21,5	100	70	11	56,5	-	110	97,5	15,5	G 1/4	24	6,5	55	9	1,767
G3K G 3/8	50 MPa	10	53	28,5	115	80	14	71,5	-	180	101	15,5	G 3/8	30	6,5	65	14	3,018
G3K G 1/2	40 MPa	13	62	33	136	100	14	80,5	-	180	110	17	G 1/2	41	8,5	80	14	5,247
G3K G 3/4	35 MPa	20	68	36	156	113	14	86,5	-	300	116,5	21	G 3/4	41	8,5	85	14	6,898
G3K G 1	35 MPa	25	82	47,5	181	118	14	100,5	138	300	130,5	24	G 1	50	8,5	85	14	9,005
G3K G 1 1/4 R	35 MPa	25	82	47,5	181	118	14	100,5	138	300	130,5	24	G 1 1/4	55	8,5	85	14	8,989
G3K G 1 1/2 R	35 MPa	25	82	47,5	181	118	14	100,5	138	300	130,5	24	G 1 1/2	60	8,5	85	14	9,213

G3K ANSI/ASME B1.20.1 NPT

Standard

TYPE	PN	DN	A	B	C	D	E	F	ØG	H	I	L	ØM	CH	K	Y	SW	KG
G3K N 1/4	50 MPa	6	42	21,5	100	70	11	56,5	-	110	97,5	15,5	N 1/4	24	6,5	55	9	1,767
G3K N 3/8	50 MPa	10	53	28,5	115	80	14	71,5	-	180	101	15,5	N 3/8	30	6,5	65	14	3,018
G3K N 1/2	40 MPa	13	62	33	136	100	14	80,5	-	180	110	17	N 1/2	41	8,5	80	14	5,247
G3K N 3/4	35 MPa	20	68	36	156	113	14	86,5	-	300	116,5	21	N 3/4	41	8,5	85	14	6,898
G3K N 1	35 MPa	25	82	47,5	181	118	14	100,5	138	300	130,5	24	N 1	50	8,5	85	14	9,005
G3K N 1 1/4 R	35 MPa	25	82	47,5	181	118	14	100,5	138	300	130,5	24	N 1 1/4	55	8,5	85	14	8,989
G3K N 1 1/2 R	35 MPa	25	82	47,5	181	118	14	100,5	138	300	130,5	24	N 1 1/2	60	8,5	85	14	9,213

+ G3K

3-WAY HIGH PRESSURE BALL VALVES

www.gemels.it

Standard schemes

L scheme

G3 K01

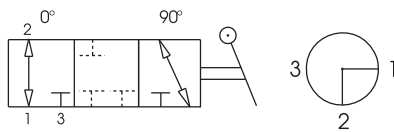

G3K DIN ISO 228 BSP

Standard

CARBON STEEL	
ØLW-K01	ITEM CODE G3K01
6	G23GGT15011A000
10	G23GGT25011A000
13	G23GGT34011A000
19	G23GGT43011A000
23	G23GGT53011A000
23	G23GGR63011A000
23	G23GGR73011A000

G3K ANSI/ASME B1.20.1 NPT

Standard

CARBON STEEL	
ØLW-K01	ITEM CODE G3K01
6	G23NNT15011A000
10	G23NNT25011A000
13	G23NNT34011A000
19	G23NNT43011A000
23	G23NNT53011A000
23	G23NNR63011A000
23	G23NNR73011A000

T scheme

G3 K02

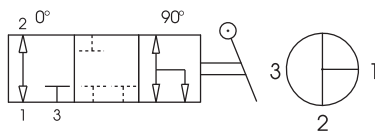

CARBON STEEL	
ØLW-K02	ITEM CODE G3K02
6	G2AGGT15011A000
10	G2AGGT25011A000
13	G2AGGT34011A000
19	G2AGGT43011A000
23	G2AGGT53011A000
23	G2AGGR63011A000
23	G2AGGR73011A000

CARBON STEEL	
ØLW-K02	ITEM CODE G3K02
6	G2ANNT15011A000
10	G2ANNT25011A000
13	G2ANNT34011A000
19	G2ANNT43011A000
23	G2ANNT53011A000
23	G2ANNR63011A000
23	G2ANNR73011A000

X scheme

G3 K14

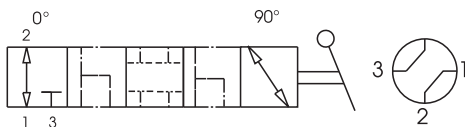

CARBON STEEL	
ØLW-K14	ITEM CODE G3K14
5	G2BGGT15011A000
7	G2BGGT25011A000
10	G2BGGT34011A000
15	G2BGGT43011A000
17	G2BGGT53011A000
17	G2BGR63011A000
17	G2BGR73011A000

CARBON STEEL	
ØLW-K14	ITEM CODE G3K14
5	G2BNNT15011A000
7	G2BNNT25011A000
10	G2BNNT34011A000
15	G2BNNT43011A000
17	G2BNNT53011A000
17	G2BNNR63011A000
17	G2BNNR73011A000

Special schemes on request

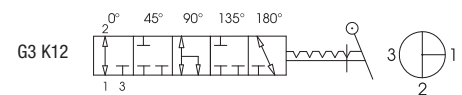
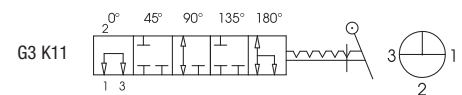
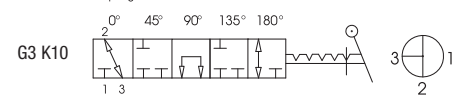
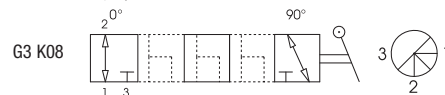
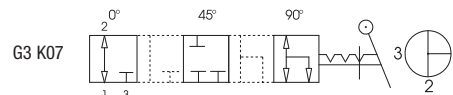
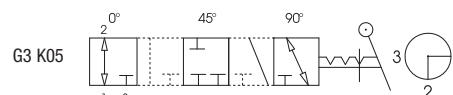
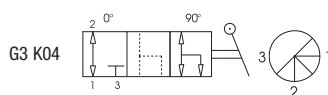
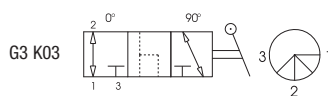

+ G3K

3-WAY HIGH PRESSURE BALL VALVES

www.gemels.it

2015 - Edition 1

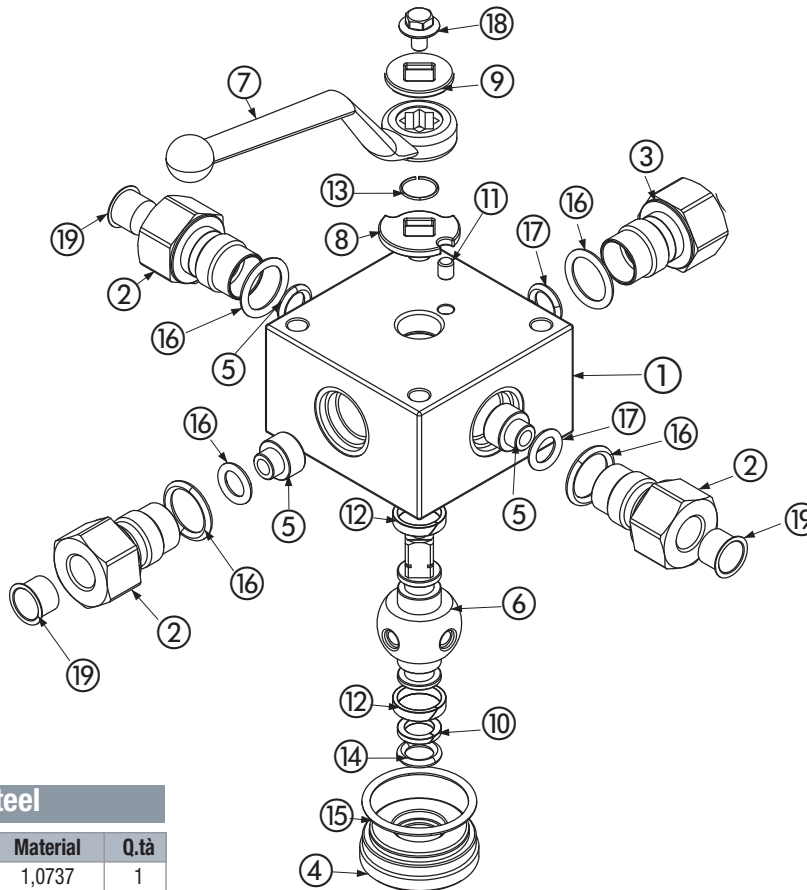

Carbon steel

Pos	Description	Material	Q.tà
1	Body	1,0737	1
2	Adapter	1,0737	4
3	Close adapter	1,0737	1
4	Stemball adapter	1,0737	1
5	Ball Seat	POM	4
6	Ball stem	1,0737	1
7	Handle	ZINC	1
8	Washer	1,0116	1
9	Washer	1,0116	1
10	Stemball ring	PTFE	2
11	Spine	1,0737	1
12	Body ring	PTFE	2
13	Seeger	1,4301	1
14	Stemball o-ring	NBR	2
15	Body o-ring	NBR	1
16	Adapter o-ring	NBR	4
17	Seal o-ring	NBR	4
18	Screw	DIN 6921 8.8	1
19	Caps	PVC	4

For further special requests please consult our technical/commercial service

On request

- Reduced bore
- O-Ring in FKM, EPDM, HNBR, KALREZ
- Seals in PTFE, PEEK, PA612, GEMPTFE, METAL TO METAL
- Special threads
- Stem in stainless steel 1,4404
- Ball in stainless steel 1,4404
- Pressure class up to PN35 MPa
- Pneumatic and electrical actuator
- Locking device