

+ GRC

2-WAY HIGH PRESSURE BALL VALVES



GRC

CARBON STEEL

- Type: ball valve GRC 2 way 
- Body: round
- Material: 1,0570/1,0570 (FOR STEM 1,4542)
- Ball seats: from DN80 up to DN125
- O-Rings: NBR, FKM, EPDM, MVQ
- Operating pressure: PN250-PN350-PN400 depending on valve size and seal materials selected
- Temp range: -20°C to +100°C depending on seal material selected

GRC	250	DN51	2	2	M	2	A	B
Type and way of valve GRC 2-way	Valves dimension of pressure (psi) PN250 PN350 PN400	Nominal dimension DN25 DN32 DN38 DN40 DN50 DN51 DN56 DN63 DN65 DN80 DN100 DN125	Body material 2 1,0570	Adapter material 2 1,0570	Stem material M 1,4542	Ball material 2 1,0570	Ball seat material A POM D PEEK G PA612 K GEMPTFE C PTFE	Adapter and stem seal material B NBR E FKM F EPDM L MVQ

STAINLESS STEEL

- Type: ball valve GRC 2 way 
- Body: round
- Material: 1,4404/1,4404 (FOR STEM 1,4542)
- Ball seats: from DN80 up to DN125
- O-Rings: NBR, FKM, EPDM, MVQ
- Operating pressure: PN250-PN350-PN400 depending on valve size and seal materials selected
- Temp range: -60°C to +230°C depending on seal material selected

GRC	250	DN51	4	4	M	4	A	B
Type and way of valve GRC 2-way	Valves dimension of pressure (psi) PN250 PN350 PN400	Nominal dimension DN25 DN32 DN38 DN40 DN50 DN51 DN56 DN63 DN65 DN80 DN100 DN125	Body material 4 1,4404	Adapter material 4 1,4404	Stem material M 1,4542	Ball material 4 1,4404	Ball seat material A POM D PEEK G PA612 K GEMPTFE C PTFE	Adapter and stem seal material B NBR E FKM F EPDM L MVQ





GRC

2-WAY HIGH PRESSURE BALL VALVES

Specialist in Ball Valves

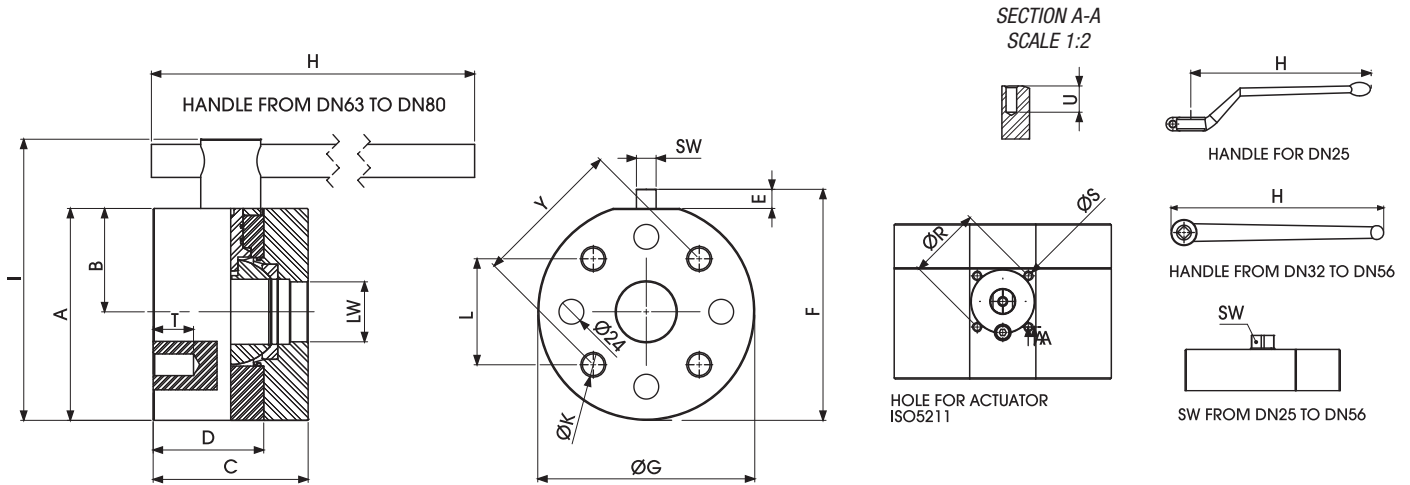

GRC CETOP250 ISO6164

Standard

																				CARBON STEEL	STAINLESS STEEL			
TYPE	PN	DN	A	B	C	D	E	F	ØG	H	I	L	Y	K	ØR	ØS	ISO5211	T	U	SW	LW	KG	ITEM CODE	ITEM CODE
GRC250	25 MPa	25	98,5	39,5	88	69	14	113	118	180	146	43,8	62	4xM10	50	M6	F05	20	10	14	25	6,317	GR2CTT52022A000	GR2CTT52044A000
GRC250	25 MPa	32	143,5	71	100	73	14	162	145	300	171	51,6	73	4xM12	50	M6	F05	21	10	17	32	12,228	GR2CTT6202PA000	GR2CTT6204NA000
GRC250	25 MPa	38	160	78	110	80	14	178,5	165	300	187,5	60,1	85	4xM16	50	M6	F05	24,5	10	17	38	16,867	GR2CTT7202PA000	GR2CTT7204NA000
GRC250	25 MPa	51	192	93	116	90	14	206	196	300	214,5	69,3	98	4xM16	70	M8	F07	25,5	10	17	47	32,855	GR2CTT8202PA000	GR2CTT8204NA000
GRC250	25 MPa	56	192	93	150	107	14	206	203	600	214,5	83,4	118	4xM20	70	M8	F07	33	10	17	58	32,855	GR2CTT9202PA000	GR2CTT9204NA000
GRC250	25 MPa	63	205	100	150	107	18	223	210	600	272	102,5	145	4xM20	70	M8	F07	36	13	19	70	36,569	GR2CTTA202PA000	GR2CTTA204NA000

GRC CETOP350 ISO6164

Standard

																				CARBON STEEL	STAINLESS STEEL			
TYPE	PN	DN	A	B	C	D	E	F	ØG	H	I	L	Y	K	ØR	ØS	ISO5211	T	U	SW	LW	KG	ITEM CODE	ITEM CODE
GRC350	35 MPa	25	102,5	39,5	88	69	14	117	118	180	117	50,9	72	4xM12	50	M6	F05	20	10	14	25	7,2	GR2CTT53022A000	GR2CTT53044A000
GRC350	35 MPa	32	141	68	105	75,5	14	158	145	300	158	56,6	80	4xM16	50	M6	F05	24	10	17	32	12,5	GR2CTT6302PA000	GR2CTT6304NA000
GRC350	35 MPa	40	161	78	110	80	14	178	165	300	178	69,5	98	4xM16	50	M6	F05	25	10	17	38	16,6	GR2CTT7302PA000	GR2CTT7304NA000
GRC350	35 MPa	50	193	94	116	90	14	210	196	300	210	83,5	118	4xM20	70	M8	F07	28	10	17	48	25	GR2CTT8302PA000	GR2CTT8304NA000
GRC350	35 MPa	65	204	100	150	107	21	224	208	600	270	102,5	145	4xM24	70	M8	F07	36	10	19	63	44	GR2CTT9302PA000	GR2CTT9304NA000
GRC350	35 MPa	80	208	100	150	107	22	233,5	215	600	279	123,7	175	4xM30	70	M8	F07	36	13	19	75	45	GR2CTTA302PA000	GR2CTTA304NA000
GRC350	35 MPa	100	251	122	200	147	26,5	277	258	600	327	141,5	200	8xM24	102	M10	F10	40	13	24	95	70	GR2CTTB302PA000	GR2CTTB304NA000
GRC350	35 MPa	125	303	148	220	170	32	330	310	900	389	-	245	8xM30	125	M12	F12	40	13	36	118	109	GR2CTTC302PA000	GR2CTTC304NA000

+ GRC

2-WAY HIGH PRESSURE BALL VALVES

www.gemels.it

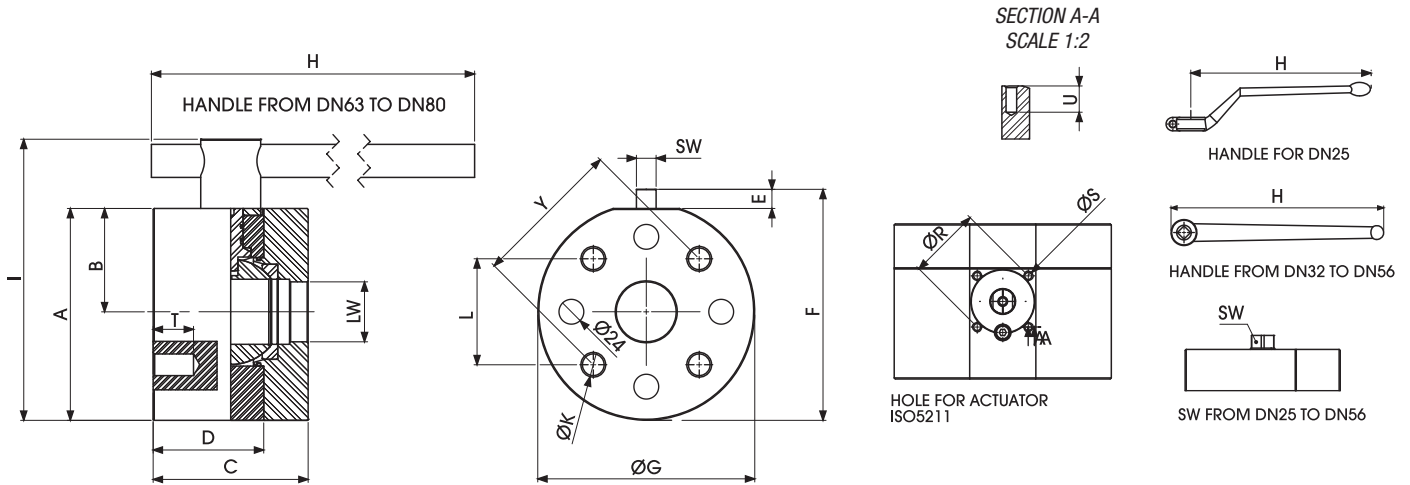

GRC CETOP400 ISO6164

Standard

																				CARBON STEEL	STAINLESS STEEL			
TYPE	PN	DN	A	B	C	D	E	F	ØG	H	I	L	Y	K	ØR	ØS	ISO5211	T	U	SW	LW	KG	ITEM CODE	ITEM CODE
GRC400	40 MPa	25	98,5	39,5	88	69	14	113	118	180	146	43,8	62	4xM10	50	M6	F05	20	10	14	25	6,317	GR2CTT54022A000	GR2CTT54044A000
GRC400	40 MPa	32	143,5	71	100	73	14	162	145	300	171	51,6	73	4xM12	50	M6	F05	21	10	17	32	12,228	GR2CTT6402PA000	GR2CTT6404NA000
GRC400	40 MPa	38	160	78	110	80	14	178,5	165	300	187,5	60,1	85	4xM16	50	M6	F05	24,5	10	17	38	16,867	GR2CTT7402PA000	GR2CTT7404NA000
GRC400	40 MPa	51	192	93	116	90	14	206	196	300	214,5	69,3	98	4xM16	70	M8	F07	25,5	10	17	47	32,855	GR2CTT8402PA000	GR2CTT8404NA000
GRC400	40 MPa	56	192	93	150	107	14	206	203	600	214,5	83,4	118	4xM20	70	M8	F07	33	10	17	58	32,855	GR2CTT9402PA000	GR2CTT9404NA000
GRC400	40 MPa	63	205	100	150	107	18	223	210	600	272	102,5	145	4xM24	70	M8	F07	36	13	19	70	36,569	GR2CTTA402PA000	GR2CTTA404NA000
GRC400	40 MPa	80	251	122	170	132	26,5	278	258	600	325	123,7	175	4xM30	102	M10	F10	38	13	24	74	65,411	GR2CTTB402PA000	GR2CTTB404NA000

+ GRC 2-WAY HIGH PRESSURE BALL VALVES

www.gemels.it

2015 - Edition 3

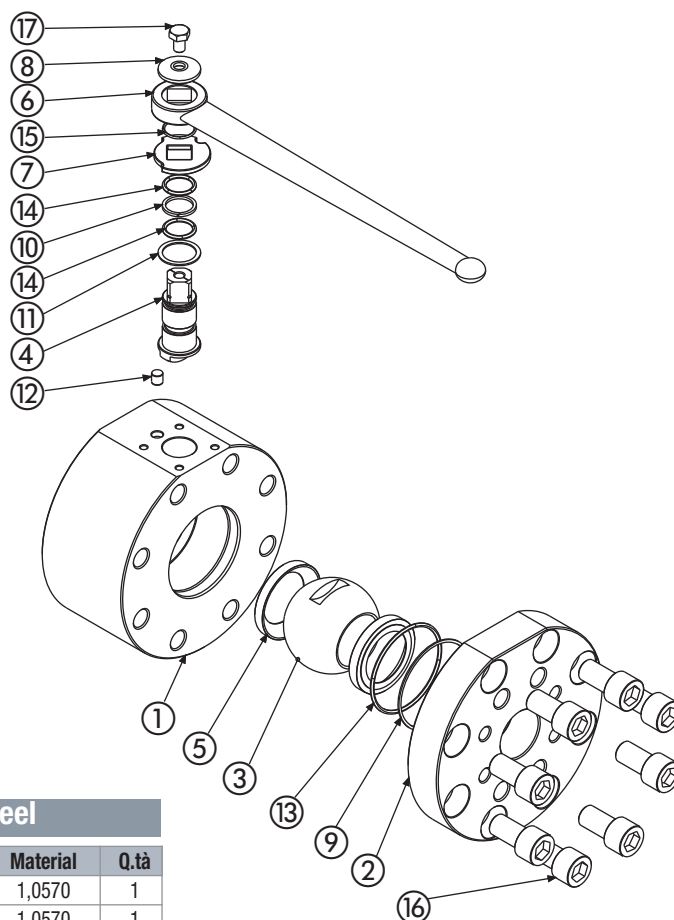

Carbon steel

Pos	Description	Material	Q.tà
1	Body	1,0570	1
2	Flange	1,0570	1
3	Ball	1,0570	1
4	Stem	1,4542	1
5	Seat	POM	2
6	Handle	1,0116	1
7	Washer	1,0116	1
8	Washer	1,0116	1
9	Flange Back-Up	PTFE	1
10	Stem Back-Up	PTFE	1
11	Stem Ring	PTFE	1
12	Pin	1,0737	1
13	Flange o-ring	NBR	1
14	Stem o-ring	NBR	2
15	Seeger	1,4301	1
16	T.C.E.I. Screw	DIN6921 8.8	8
17	T.E. Screw	DIN6921 8.8	1

- On request**
- Reduced bore
 - O-Ring in FKM, EPDM, HNBR, KALREZ
 - Seals in PTFE, PEEK, PA612, GEMPTFE, METAL TO METAL
 - Special Threads
 - Stem in stainless steel 1,4404
 - Ball in stainless steel 1,4404
 - Pressure class up to PN40 Mpa
 - Pneumatic and electrical actuator
 - Locking device

Stainless steel

Pos	Description	Material	Q.tà
1	Body	1,4404	1
2	Flange	1,4404	1
3	Ball	1,4404	1
4	Stem	1,4542	1
5	Seat	POM	2
6	Handle	1,0116	1
7	Washer	1,0116	1
8	Washer	1,0116	1
9	Flange Back-Up	PTFE	1
10	Stem Back-Up	PTFE	1
11	Stem Ring	PTFE	1
12	Pin	1,4404	1
13	Flange o-ring	NBR	1
14	Stem o-ring	NBR	2
15	Seeger	1,4301	1
16	T.C.E.I. Screw	ISO4762 A2	8
17	T.E. Screw	ISO4762 A2	1

- On request**
- Reduced bore
 - O-Ring in FKM, EPDM, HNBR, KALREZ
 - Seals in PTFE, PEEK, PA612, GEMPTFE, METAL TO METAL
 - Special Threads
 - Pressure class up to PN40 Mpa
 - Pneumatic and electrical actuator
 - Locking device

For further special requests please consult our technical/commercial service